

- Registered design in Japan, China, and the European Union.
- Design registration pending in the United States of America.

PORTABLE SURFACE ROUGHNESS TESTER SURFTEST SJ-210 SERIES

This is it! A small, lightweight, and extremely easy to use surface roughness measurement instrument that lets you view surface roughness waveforms right on the color LCD screen.



The SurfTest SJ-210 is a user-friendly surface roughness measurement instrument designed as a handheld tool that can be carried with you and used on-site.



Easy to use

2.4-inch color graphic LCD with backlight

The color LCD provides excellent readability and an intuitive display that's easy to navigate. The LCD also includes a backlight for improved visibility in dark environments.

Simple key layout

The SurfTest SJ-210 can be operated easily using the keys on the front of the unit and under the sliding cover.

Highly functional

Advanced data storage capabilities

Up to 10 measurement conditions and one measured profile can be stored in the internal memory.

Optional memory card

An optional memory card can be used as an extended memory to store large quantities of measured profiles and conditions.

Password protection

Access to each feature can be password-protected, which prevents unintended operations and allows you to protect your settings.

Multilingual support

The display interface supports 16 languages, which can be freely switched.

Stylus alarm (patent pending in Japan)

An alarm warns you when the cumulative measurement distance exceeds a preset limit.

Extensive analysis and display features

Complies with many industry standards

The SurfTest SJ-210 complies with the following standards: JIS (JIS-B0601-2001, JIS-B0601-1994, JIS B0601-1982), VDA, ISO-1997, and ANSI.

Displays assessed profiles and graphical data

In addition to calculation results, the SurfTest SJ-210 can display sectional calculation results and assessed profiles, load curves, and amplitude distribution curves.



Surf

Color graphic LCD

Intuitive display that's clear, sharp, and legible.

Large, 2.4-inch LCD

The large LCD provides excellent readability.

Backlight

The backlight improves visibility in dark environments.

Operation keys

- The keys on the front of the unit and under the sliding cover are clearly labeled and easy to use.
- The user-friendly screen layout and arrow keys provide intuitive operability.
- Displayed settings can be changed easily by using the left and right arrow keys. (Patent pending in Japan.)
- Infrequently used keys are hidden under the sliding cover to prevent unintended operations.

Drive unit

The drive unit can be separated from the display unit by using a cable, allowing more flexible measurement. The driver can be separated and reattached in one simple step.



There are many different kinds of drive units and detectors available.

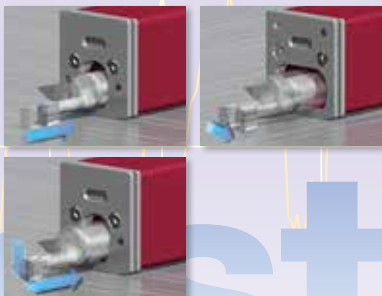

Battery

The battery charges in one quarter the time of previous Mitutoyo products.



Applicable standards

In addition to JIS and ISO, the SurfTest SJ-210 also complies with ANSI and VDA standards.

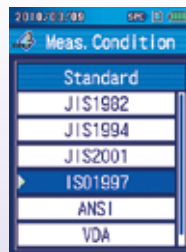

Multilingual support

The display interface supports 16 languages.



High-speed USB communication

Data can be transferred to and from a computer via the high-speed USB interface.



Memory card support

The memory card slot lets you store large amounts of data onto a memory card.

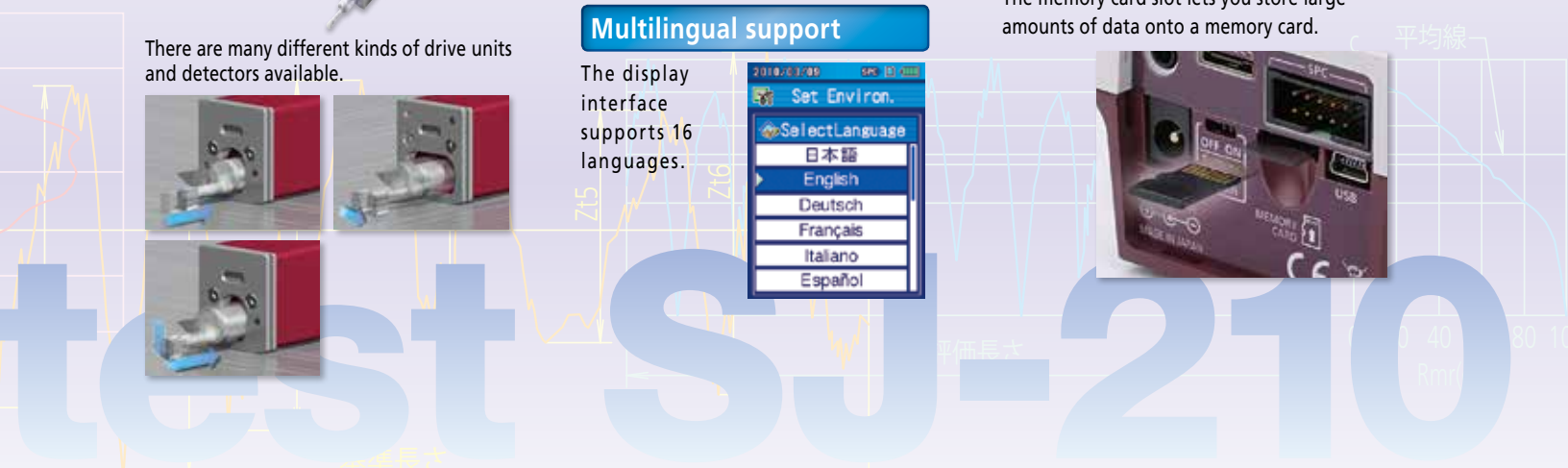

test SJ-210

Many features in a compact body

Extensive display features that assist measurement

- The highly visible 2.4-inch color graphic LCD with backlight lets you see the screen easily even in dark environments.



- Pass/fail results are displayed in color.



- Assessed profiles, load curves, and amplitude distribution curves can be displayed in addition to calculation results. Assessed profiles can also be zoomed up and down.

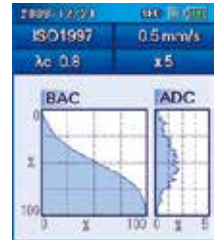

- The display mode can be freely switched between portrait and landscape.
- Calculation results are displayed in large characters.

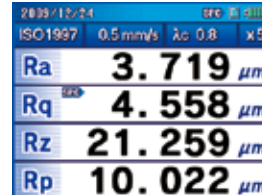

Advanced data storage capabilities

- Up to 10 measurement conditions can be stored in the internal memory. Conditions can be quickly read according to the workpiece.
- An optional memory card can be used as an extended memory to store large quantities of measured profiles and conditions. *See page 10 for details about the memory card.

Storage Capacity

| Data type | Internal memory | Memory Card (option) |
|-----------------------|-----------------|----------------------|
| Measured profiles | 1 | 10000 |
| Calculation result | 10 | |
| Measurement condition | 10 | |



- Many interface options:
 - A USB interface is equipped as standard.
 - The SurfTest SJ-210 also provides an RS-232C output, Digimatic output, printer output, and footswitch input.



Advanced features

- The multilingual display interface supports 16 languages, which can be freely switched.
- Access to features can be password-protected.
- A quick-charge, long-life battery is provided.

Stylus alarm function

- An alarm warns you when the cumulative measurement distance exceeds a preset limit. This feature can be used to prevent problems that would be caused by worn out styli. Any value can be specified as the limit. (Patent pending in Japan)

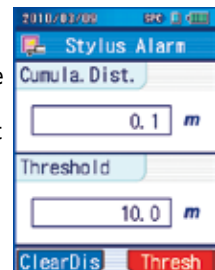

Easy setting

- Displayed settings can be easily changed by pressing the left and right arrow keys under the sliding cover. For example, these keys can be used to switch the cut-off value (λ_c) and the number of sampling lengths (N) on the measurement screen. (Patent pending in Japan)



(Example of the measurement screen)

Setting parameters and recalculating results

- The required parameters can be selected from the screen. The sub-menu also lets you specify detailed settings such as the tolerance. After completing measurement, the parameters can be changed and calculation can be executed again* using the new parameters.

*May not be possible, depending on the measurement conditions.

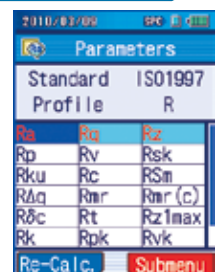

Detector / Drive Units

Battery-powered portability scores when making surface roughness measurements on the shop floor.

Capable of performing measurements in any orientation, including vertical and upside-down. Optional accessories, such as a height gage adapter, allow measurements to be performed efficiently in various situations and setups.

*Refer to pages 8 to 11 for details of the optional accessories available.



A wide variation in system setup is possible with the detector + drive unit + display unit combination.

Highly functional detectors and drive units

The driver can be separated from the display unit and reattached in one easy step.



[Storing drive unit in Display unit]

[Detaching drive unit from Display unit]

Detector supplied as standard



Selectable from the following two items.

- Measuring force: 0.75mN
Stylus profile: Tip radius 2µm
Tip angle 60°
- Measuring force: 4mN
Stylus profile: Tip radius 5µm
Tip angle 90°

Drive units

| Standard drive unit | Transverse tracing drive unit | Retractable drive unit |
|---------------------|-------------------------------|------------------------|
|---------------------|-------------------------------|------------------------|

- Popular standard drive unit
- Best suited for measurement of narrow, shrouded workpiece features such as crankshaft, EDM parts, etc.
(Patent Registered in Japan)
- The detector is in the retracted position at rest so it is immune from damage when inserted into a feature whose profile cannot be easily seen, such as a blind hole, etc.



Optional detectors

A wide range of optional detectors is available, including detectors for small holes, extra small holes, gear tooth surfaces, and deep grooves.

*See page 8 for details about the Detectors.

Carrying case

A convenient carrying case is supplied as standard for protecting the instrument in the field.



Specifications

| Type of detector | | Standard drive unit type | | Retractable drive unit type | Transverse tracing drive unit type | |
|---|----------------------|--|----------------------|-----------------------------|---|--|
| Model No. | | SJ-210 (0.75mN type) | SJ-210 (4mN type) | SJ-210 (4mN type) | SJ-210 (4mN type) | |
| Order No. | | 178-561-01A | 178-561-02A | 178-563-02A | 178-565-02A | |
| inch/mm | | | | | | |
| Measuring range | X axis | .69" (17.5mm) | | | .22" (5.6mm) | |
| | Z axis (Detector) | 14200 μin (-7900μin~+6300μin) / 360μm (-200μm ~ +160μm) | | | | |
| | Range | 14170μin / 8μin (360μm / 0.02μm), 4000μin / .2μin (100μm / 0.006μm), 1000μin / .08μin (25μm / 0.002μm) | | | | |
| | Range / Resolution | 14170μin / 8μin (360μm / 0.02μm), 4000μin / .2μin (100μm / 0.006μm), 1000μin / .08μin (25μm / 0.002μm) | | | | |
| Measuring speed | | Measuring: 0.01, 0.02, 0.03 in/s (0.25mm/s, 0.5mm/s, 0.75mm/s) Returning: 1mm/s | | | | |
| Measuring force / Stylus tip | | 0.75mN type: 0.75mN / 2μmR 60°, 4mN type: 4mN / 5μmR 90° | | | | |
| Skid force | | Less than 400mN | | | | |
| Applicable standards | | JIS '82 / JIS '94 / JIS '01 / ISO '97 / ANSI / VDA | | | | |
| Assessed profiles | | Primary profile / Roughness profile / DF profile / Roughness profile-Motif | | | | |
| Evaluation parameters | | Ra, Rc, Ry, Rz, Rq, Rt, Rmax, Rp, Rv, R3z, Rsk, Rku, RPl, Rsm, Rmax, Rz1max, S, HSC, RzJIS, Rppi, RΔa, RΔq, Rlr, Rmr, Rmr(c), R Δ c, Rk, Rpk, Rvk, Mr1, Mr2, A1, A2, Vo, Rpm, tp, Htp, R, Rx, AR, Possible Customize | | | | |
| Analysis graphs | | Bearing area curve / Amplitude distribution curve | | | | |
| Filters | | Gaussian, 2CR75, PC75 | | | | |
| Cut off length | λ c | 0.003, 0.01, 0.03, 0.1" (0.08, 0.25, 0.8, 2.5mm) | | | | |
| | λ s | 100, 300μin (2.5, 8μm) or none | | | | |
| Sampling length | | 0.003, 0.01, 0.03, .1" (0.08, 0.25, 0.8, 2.5mm) | | | | |
| Number of Sampling lengths (xn) | | ×1, ×2, ×3, ×4, ×5, ×6, ×7, ×8, ×9, ×10, Arbitrary 0.01~.63" (.0001" interval) [(0.3~16.0mm: 0.01mm interval)] | | | ×1, ×2, ×3, ×4, ×5, ×6, ×7, ×8, ×9, ×10, Arbitrary .0118 ~ .22" (.0001" Interval) [(0.3 ~ 5.6mm: 0.01mm Interval)] | |
| LCD dimensions | | 1.45 x 1.93" (36.7x48.9 mm) | | | | |
| Display languages | | Japanese, English, German, French, Italian, Spanish, Portuguese, Korean, Traditional Chinese, Simplified Chinese, Czech, Polish, Hungarian, Turkish, Swedish, Dutch | | | | |
| Calculation result display | | Vertical display: 1 parameter / 3 parameter / trace to measurements Horizontal display: 1 parameter / 4 parameter / trace to measurements (Horizontal display is invertable) | | | | |
| Printing function *1 (Dedicated printer is required separately.) | | Measurement conditions / Calculation results / Calculation results for each sampling length / Assessed profile / Bearing area curve / Amplitude distribution curve / Environment setting information | | | | |
| External I/O | | USB I/F, Digimatic Output, Printer Output, RS-232C I/F, Foot SW I/F | | | | |
| Customization | | Desired parameters can be selected for calculation and display | | | | |
| GO/NG judgment *2 | | By max value / 16% / Standard deviation | | | | |
| Storage of measurement condition | | Save the conditions at power OFF | | | | |
| Functions | Storage | Internal memory: Measurement condition (10sets), Measured profile (1set) Memory card (Option): 500 measurement conditions, 10000 measured profiles, 500 display images Text file (Measurement conditions / Measured profile / Assessed profile / Bearing area curve / Amplitude distribution curve) | | | | |
| | Calibration | Saves last inputted nominal value of specimen / Average calibration with multiple measurement (Max.5 times) is available | | | | |
| Power-saving function | | Auto-sleep off function (10-600sec) *3 | | | | |
| Power supply | | Two-way power supply: battery (rechargeable Ni-MH battery) and AC adapter *Charging time: about 4 hours (may vary due to ambient temperature) *Endurance: about 1000 measurements (differs slightly due to use conditions / environment) | | | | |
| Size (WxDxH) | Display unit | 2.05 x 2.6" x 6.3" (52.1x65.8x160mm) | | | | |
| | Drive unit | 4.5 x .9 x 1.02" (115x23x26mm) | | | | |
| Mass | | About 1.1lbs (500g) (Display unit + Drive unit + Standard detector) | | | | |
| Standard accessories | | 12BAA303 Connecting cable *4 178-602 Roughness specimen (Ra 3.00μm) 12BAK699 Carrying case 12BAK700 Calibration stage 12BAK820 Protective sheets for display AC Adapter Operation manual Quick reference manual Warranty | | | 12BAA303 Connecting cable *4 178-606 Roughness specimen (Ra 1.00μm) 12AAE643 Point-contact adapter 12AAE644 V-type adapter 12BAK699 Carrying case 12BAK700 Calibration stage 12BAK820 Protective sheets for display AC Adapter, Operation manual Quick reference manual, Warranty | |

*1: Order the SJ-210 printer (No.178-421A, optional accessory) separately.
See page 10 for details about the SJ-210 printer.

*2: Standard deviation only can be selected in ANSI. 16% rule cannot be selected in VDA.

*3: Auto-sleep function is invalid when AC adaptor is used.

*4: For connecting the calculation display unit and drive unit.

Dimension Display Unit and Drive Unit

Display unit, Drive unit

Unit: inch(mm)

- Drive unit stored inside display unit (Standard detector installed in drive unit)

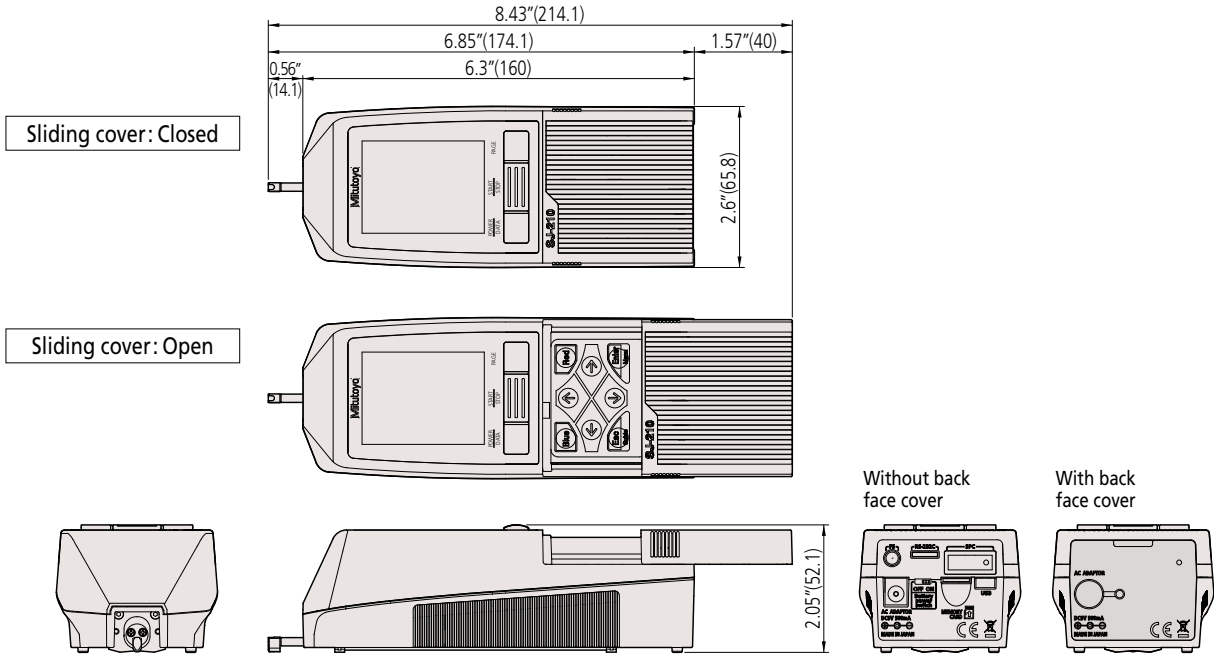

- Drive unit not stored inside display unit (Standard detector installed in drive unit)

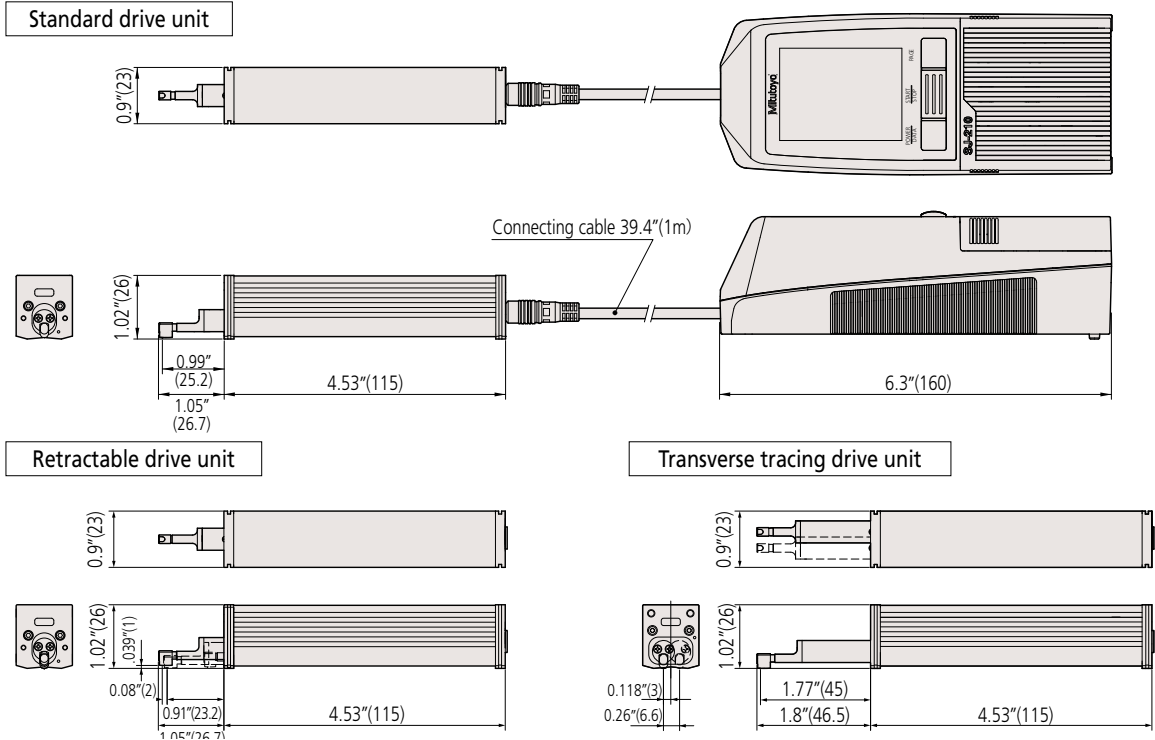

Dimensions Detectors and Drive units

Detectors

Unit: inch(mm)

Standard detectors

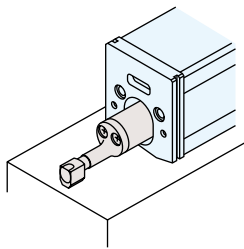

| Order No. | Measuring force | Stylus profiles* | Remarks column |
|-----------|-----------------|------------------|--|
| 178-296 | 0.75mN | 2 μ mR/60° | Dedicated to the standard/retractable drive unit |
| 178-390 | 4 mN | 5 μ mR/90° | |
| 178-387 | 0.75mN | 2 μ mR/60° | Dedicated to the transverse tracing drive unit |
| 178-386 | 4 mN | 5 μ mR/90° | |
| 178-395 | 0.75mN | 2 μ mR/60° | Dedicated to the standard/retractable drive unit |
| 178-391 | 4 mN | 10 μ mR/90° | |

*Tip radius / Tip angles

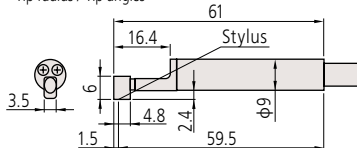

Gear-tooth surface detectors

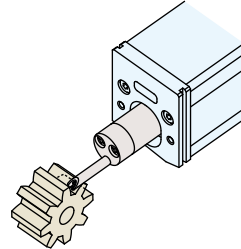

| Order No. | Measuring force | Stylus profiles* |
|-----------|-----------------|------------------|
| 178-388 | 0.75mN | 2 μ mR/60° |
| 178-398 | 4 mN | 5 μ mR/90° |

*Tip radius / Tip angles

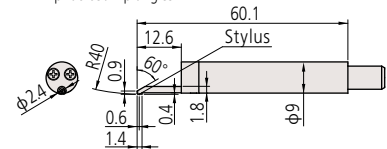

Small hole detectors

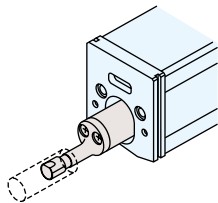

| Order No. | Measuring force | Stylus profiles* | Remarks column |
|-----------|-----------------|------------------|--|
| 178-383 | 0.75mN | 2 μ mR/60° | Minimum measurable hole diameter:4.5mm |
| 178-392 | 4 mN | 5 μ mR/90° | |

*Tip radius / Tip angles

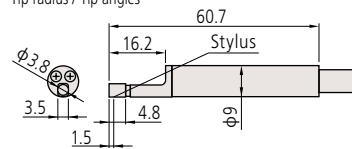

Deep groove detectors

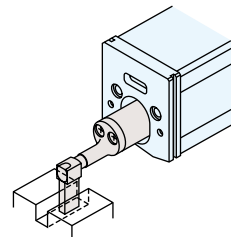

| Order No. | Measuring force | Stylus profiles* | Remarks column |
|-----------|-----------------|------------------|---|
| 178-385 | 0.75mN | 2 μ mR/60° | Not available for the transverse tracing drive unit |
| 178-394 | 4 mN | 5 μ mR/90° | |

*Tip radius / Tip angles

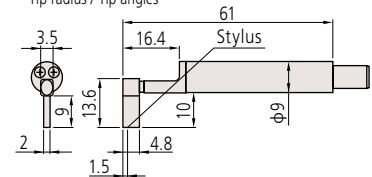

Extra small hole detectors

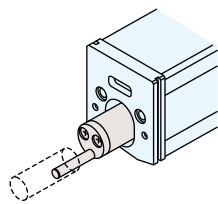

| Order No. | Measuring force | Stylus profiles* | Remarks column |
|-----------|-----------------|------------------|--|
| 178-384 | 0.75mN | 2 μ mR/60° | Minimum measurable hole diameter:2.8mm |
| 178-393 | 4 mN | 5 μ mR/90° | |

*Tip radius / Tip angles

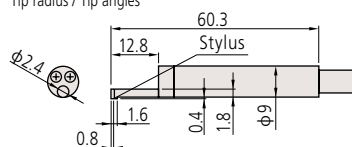

Drive units

| Order No. | |
|-----------|---|
| 178-230-2 | Standard drive unit |
| 178-233-2 | S-Drive unit |
| 178-234-2 | S-Drive unit set (includes point-contact adapter) |
| 178-235 | R-Drive unit |



Optional Accessories For Drive Unit

Drive unit accessories

Nosepiece for flat surface

No.12AAA217

*Not available for the transverse tracing drive unit.



Nosepiece for cylindrical surface

No.12AAA218

*Not available for the transverse tracing drive unit.



V-type adapter

No.12AAE644

*Transverse tracing drive unit type standard accessories.

*Dedicated to the transverse tracing drive unit.

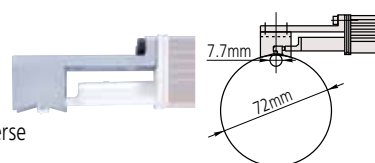

Point-contact adapter

No.12AAE643

*Transverse tracing drive unit type standard accessories.

*Dedicated to the transverse tracing drive unit.

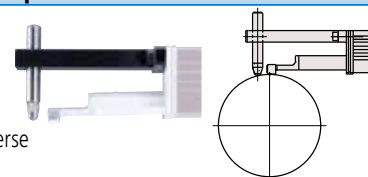

Extension rod (50mm) (Note: Extension is possible with only a single rod.)

No.12AAA210

*Not available for the transverse tracing drive unit.

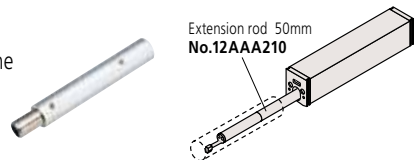

Extension cable (1m) (Note: Extension is possible with only a single cable.)

No.12BAA303

*For connecting between calculation display unit and drive unit.

Support feet set

No.12AAA216

*Not attachable to the detector side of the transverse tracing drive unit.



Vertical positioning adapter

No.12AAA219

*Not available for the transverse tracing drive unit.

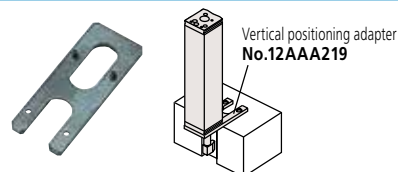

Magnetic stand adapter

No.12AAA221 (ø8mm)

No.12AAA220 (ø9.5mm)

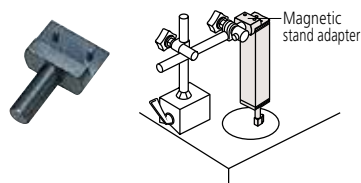

Height gage adapter

No.12AAA222 (9×9mm)

No.12AAA233 (1/4in×1/2 in)

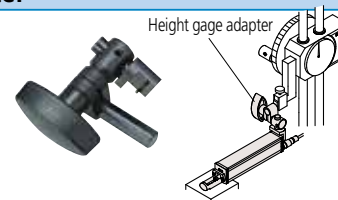

Setting attachments

* Not available for the transverse tracing drive unit

Enhances measurement efficiency by facilitating the measurement setup of multiple workpieces of the same type and of the hard-to-access sections of a workpiece.

Setting attachment: V type for measuring in the cylinder axis direction

No.178-033

The V-width is adjustable to the cylinder diameter facilitating axial measurement of a wide range of cylinder diameters.

- Adjustable range: ø 5 ~ 150mm



Setting attachment: Magnetic slider type

No.178-034

Best suited for measurement of the flat surface of a workpiece that has partial indentions and steps and that is hard to set the drive unit. Combination use with the magnet type specimen holder (Option No. 12AAA910) further improves the ease of operation.



Setting attachment: Inside diameter type

No.178-035

Greatly facilitates measurement of internal wall surfaces, for example, a cylinder block.

- Applicable diameter: ø 75 ~ ø 95mm
- Accessible depth: 30 ~ 135 mm



Optional Accessories For External Equipment

Printer for SJ-210

Assessed profiles and calculation results and curves can be printed out by connecting the SJ-210-dedicated printer, which is palm sized 3.7 x 4.9 x 2.7" (WxDxH: 93x125x70mm) and can run on an internal battery.

- Power supply can be selected. (AC adaptor or battery pack)
- Printable items: Measurement conditions, calculation results, assessed profile, bearing area curve (BAC), amplitude distribution curve (ADC), and environment settings.



178-421A

Unit configuration:

- ① Printer main unit
- ② Printer connecting cable
- ③ Printing paper 6-pack
- ④ Battery pack 1 piece
- ⑤ Exclusive use AC adaptor (with AC power cord) 1 piece



Example of the connection with **SJ-210**

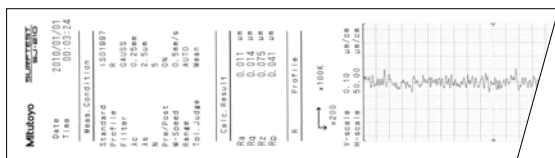

Example of the output by the printer

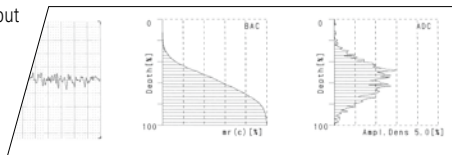

Printer for SJ-210 supplies:

Printing paper (5-pack) **No. 12AAA876**

Digimatic mini processor DP-1VR

By connecting this printer to the SurfTest SJ-210's digimatic output, you can print calculation results, perform a variety of statistical analyses, draw a histogram or D chart, and also perform complicated operations for X-R control charts.



264-504-5A

SJ-210 → DP-1VR Connecting cable
 1m: No. 936937 Digimatic SPC cable
 2m: No. 965014 Digimatic SPC cable

Memory card

A memory card for saving 500 measurement conditions, 10,000 measured profiles, 500 display images, text file (measurement conditions, measured profiles, assessed profiles, BAC, ADC)



*Not all memory cards can be recognized. Please use the memory card recommended by Mitutoyo.

No. 12AAL069

Optional Accessories For External Output

Simplified communication program for SURFTEST SJ series

The SurfTest SJ-210 has a USB interface, enabling data to be transferred to spreadsheet or other software. We also provide a program that lets you create inspection record tables using a Microsoft Excel* macro.

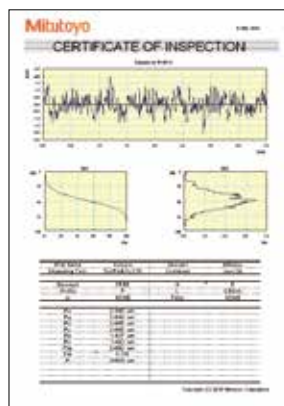
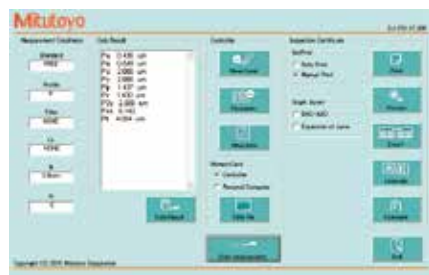

Required environment*:

- OS: Windows XP-SP3
- Spreadsheet software: Microsoft Excel 2002
- Windows Vista
- Microsoft Excel 2003
- Windows 7
- Microsoft Excel 2007
- Windows 8 (32/64bit)
- Microsoft Excel 2010/13

*Windows OS and Microsoft Excel are products of Microsoft Corporation.

The optional USB cable is also required.

- USB cable for SJ-210 series (2m)

No. 12AAL068

*Will not work with MS Excel 2016

This program can be downloaded for free from the Mitutoyo website.
<http://www.mitutoyo.com>

Footswitch

A footswitch is used to trigger measurement. This tool is very useful in cases where you need to measure the same workpiece multiple times using jigs and other fixtures.



No. 12AAJ088

Input Tool: Calculation results input unit

SurfTest SJ-210 calculation results can be loaded directly into commercial spreadsheet software via this unit simply by connecting it to the USB connector on a computer or a PS/2 type keyboard connector. (See Catalog No. E4250-264 for details.)



USB keyboard signal conversion model
IT-012U No. 264-012-10

PS/2 keyboard signal conversion model
IT-005D No. 264-005

Coordinate Measuring Machines

Vision Measuring Systems

Form Measurement

Optical Measuring



Sensor Systems

Test Equipment
and Seismometers

Digital Scale and DRO Systems

Small Tool Instruments
and Data Management

Whatever your challenges are, Mitutoyo supports you from start to finish.

Mitutoyo is not only a manufacturer of top-quality measuring products but one that also offers qualified support for the lifetime of the equipment, backed by comprehensive services that ensure your staff can make the very best use of the investment.

Apart from the basics of calibration and repair, Mitutoyo offers product and metrology training, as well as IT support for the sophisticated software used in modern measuring technology. We can also design, build, test and deliver measuring solutions and even, if deemed cost-effective, take your critical measurement challenges in-house on a sub-contract basis.



Find additional product literature
and our product catalog

www.mitutoyo.com

Note: All information regarding our products, and in particular the illustrations, drawings, dimensional and performance data contained in this printed matter as well as other technical data are to be regarded as approximate average values. We therefore reserve the right to make changes to the corresponding designs. The stated standards, similar technical regulations, descriptions and illustrations of the products were valid at the time of printing. In addition, the latest applicable version of our General Trading Conditions will apply. Only quotations submitted by ourselves may be regarded as definitive. Specifications are subject to change without notice.

Mitutoyo products are subject to US Export Administration Regulations (EAR). Re-export or relocation of our products may require prior approval by an appropriate governing authority.

Trademarks and Registrations

Designations used by companies to distinguish their products are often claimed as trademarks. In all instances where Mitutoyo America Corporation is aware of a claim, the product names appear in initial capital or all capital letters. The appropriate companies should be contacted for more complete trademark and registration information.

Mitutoyo

Mitutoyo America Corporation

www.mitutoyo.com

One Number to Serve You Better

1-888-MITUTOYO (1-888-648-8869)

M³ Solution Centers:

Aurora, Illinois (Headquarters)

Boston, Massachusetts

Huntersville, North Carolina

Mason, Ohio

Plymouth, Michigan

City of Industry, California

Birmingham, Alabama

Renton, Washington

Houston, Texas